

## Clipper® Shelving Features Hi-Performance® Box Beam Shelves

Penco Clipper Hi-Performance shelves are produced on a state-of-the-art production line that begins with a flat steel blank and ends with a completed shelf. The result is a shelf with an exceptional strength to weight ratio.

- A. Front and rear flanges of each shelf utilize Box Beam construction for extra strength – no additional reinforcing necessary.
- B. Sides are double flanged and accept additional reinforcements if required.
- C. Flanges are welded to the underside of shelf on 3" centers.
- D. Corners are lapped and welded.
- E. Shelves are available in three main capacity ranges: *Medium, Heavy Duty* and *Extra Heavy Duty*.

At the heart of the Clipper Shelving System is the ingenious Penco Clipper Clip. It is easily installed, holds the shelf firmly in place, can be repositioned at any time, and actually helps make the shelving more rigid.

Clipper Shelving offers a wide variety of sizes and capacities. This gives you the flexibility to provide top quality storage for a simple back room area, or a sophisticated multi-level or high-rise application.

The following pages detail the units, components and accessories for designing a shelving system that meets your individual needs. You can't buy finer industrial grade shelving than Penco Clipper.



Automatic shelf welding on Hi-Performance shelf production line.

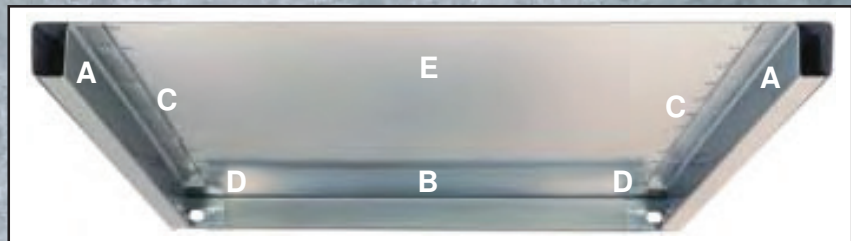

Cross Section of a Hi-Performance shelf.



Clipper Clip allows shelf adjustment on 1" vertical centers.



Four Clipper Compression Clips included with each shelf. Shelf is held tight against post.

**CLIPPER®**  
S H E L V I N G



# Clipper® Shelving Versatility

Versatile Clipper Shelving can be accessorized for any job.



**Back Panel**  
Completely closes the back of shelving units and provides lateral stability.

**Full Height Dividers**  
Used to subdivide the shelf opening into smaller units. Punched top and bottom for attachment to shelves.

**Heavy Duty Modular Drawers**  
Provides secure high density storage for small parts. 100% full extension.

**Shelf Boxes**  
Strong steel open topped box for storing small parts. Equipped with built-in stop.

**Partial Divider**  
Divides shelf surface into sections.

**Bin Front**  
To retain small bulk parts on shelf.

**Finished End Panel**  
An optional attractive row end without exposed fasteners. (Not shown.)

**Clipper Hi-Performance® Shelf**  
Available in 19 sizes and 4 classes of load carrying capacity. May be clipped or bolted to posts.

**Box Post**  
Used as a common front post or row end. Allows independent 1" vertical adjustability and access to the full shelf width.

**Offset Angle Post**  
Roll formed for strength and punched on 1" centers for shelf adjustment. Can be used at front or back of unit.

**Sliding Divider**  
Formed to fit around front and rear flanges of the shelf. May be positioned anywhere along shelf surface.

**Back Braces**  
Attaches to rear posts of open type shelving to ensure lateral stability.

**Side Braces**  
Eliminates front to back sway on open type shelving.

**Base Strip**  
Designed to close the space between the bottom shelf and floor to promote good housekeeping.

**Side Panel**  
Steel sheet used to enclose shelving sides or as a partition between sections placed side by side.

**Label Holder**  
Accepts 7/8" labels.

**CLIPPER®**  
SHELVING

## Growth Dimension Considerations

Several factors contribute to dimensional growth of a continuous row of shelving beyond specified dimensions. To determine the overall dimension of a continuous row of shelving employing box posts, refer to detail drawings and table below.

## Choice of Post Arrangements

Penco standard shelving units employ box posts at front and offset angle posts at rear for each section. Other post assembly plans may be employed using offset angle posts at front and rear, when ordered as individual component parts. The illustrations below show typical growth for 36" wide units using two types of post arrangements.



### How To Order Clipper Units

Virtually all shelving storage needs may be satisfied by ordering standard shelving units as illustrated on the following pages.

These units are shipped KD with all required components, shelf clips, hardware and assembly instructions.

To order standard shelving units 87" high:

1. Determine the shelving type desired (open, closed or ledge).
2. Determine shelf width and depth.
3. Order by catalog number as many basic units as required to form a continuous row of shelving.
4. Order by catalog number one ending kit to end each row.
5. Select the appropriate accessories for your application.

### Growth Showing Penco High Performance® Shelves

#### Box Posts Front, Angle Posts Rear

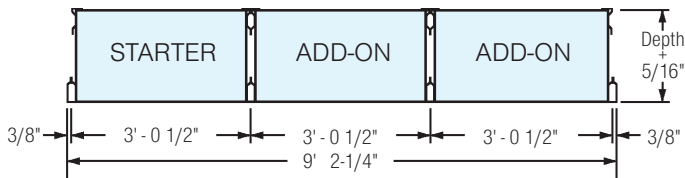

#### Angle Posts Front & Rear

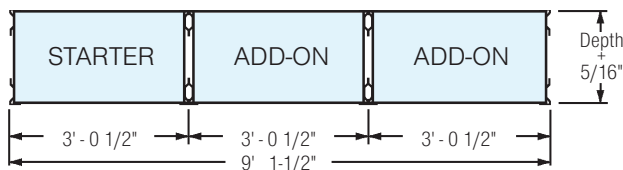

All dimensions are theoretical subject to manufacturing tolerances.

### Growth Showing Clipper Conventional Flange Shelves

#### Box Posts Front, Angle Posts Rear

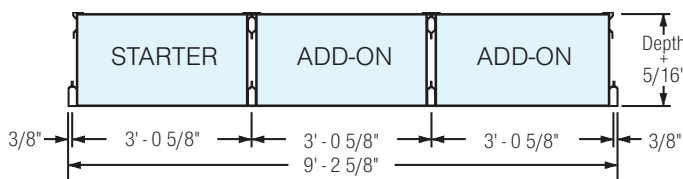

#### Angle Posts Front & Rear

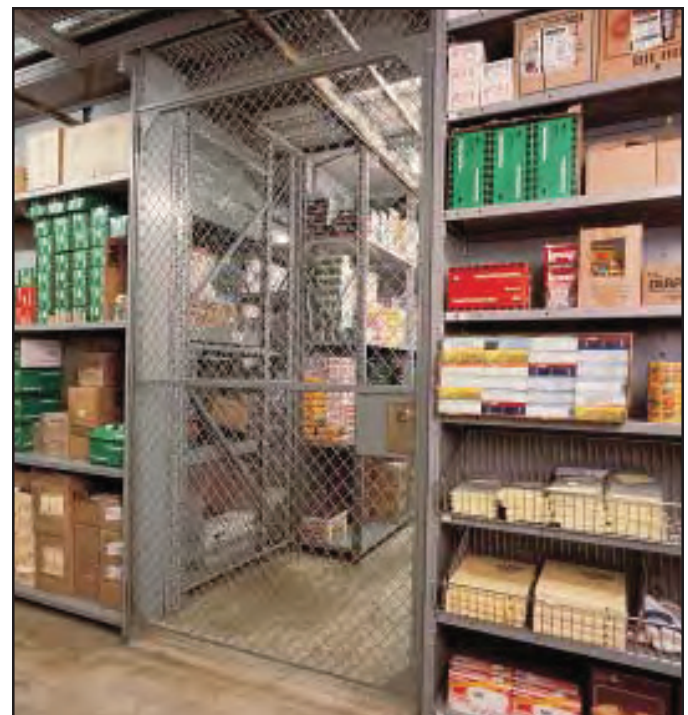
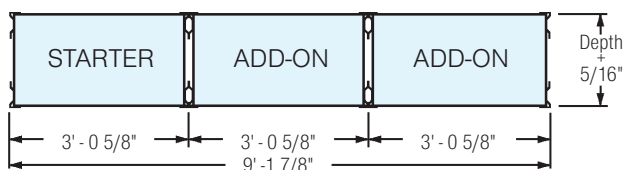

Clipper Open & Closed Shelving in a retail storage lock-up area.



# Open Clipper Units

Open type shelving is the basic and most economical shelving design for general purpose use. Backs and sides are open, except that sections are stabilized by sway braces.

For convenient ordering, 36 different open configurations of Basic Units are shown below with their respective End Kits. The completed units below utilize Heavy Duty Hi-Performance®

Shelves with box posts at front and offset angle posts at rear. Label holders are not included. Refer to page 3 for ordering instructions.

The standard stock color for Clipper shelving is 028 Gray. Refer to the inside back cover for complete color information. Many other configurations can be designed from the component parts and accessories on the following pages.

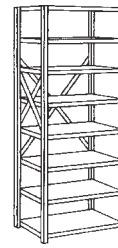

- |                        |                        |
|------------------------|------------------------|
| <b>Basic Unit</b>      | <b>End Kit</b>         |
| 1 box post             | 1 box post             |
| 2 angle posts          | 1 set side sway braces |
| 1 set side sway braces | shelves                |
| 1 set back sway braces | hardware               |



## OPEN TYPE SHELVING

Box Post at Front  
Offset Angle Posts at Rear

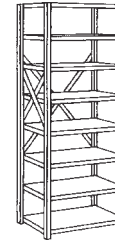
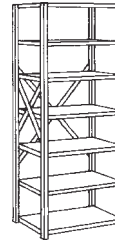
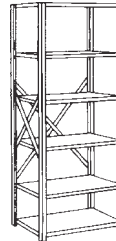
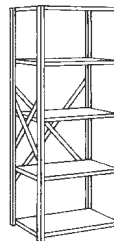

Dimensions (Inches)			Capacity ** Per Shelf	5 Shelf	6 Shelf	7 Shelf	8 Shelf	End Kit
W	D	H	Pounds	Basic Unit Cat. No.	Basic Unit Cat. No.	Basic Unit Cat. No.	Basic Unit Cat. No.	End Kit Cat. No.
36	12	87	800	1H7015	1H7016	1H7017	1H7018	101287
36	18	87	850	1H7025	1H7026	1H7027	1H7028	101887
36	24	87	800	1H7035	1H7036	1H7037	1H7038	102487
42	12	87	600	1H7045	1H7046	1H7047	1H7048	101287
42	18	87	600	1H7055	1H7056	1H7057	1H7058	101887
42	24	87	600	1H7065	1H7066	1H7067	1H7068	102487
48	12	87	500	1H7075	1H7076	1H7077	1H7078	101287
48	18	87	500	1H7085	1H7086	1H7087	1H7088	101887
48	24	87	530	1H7095	1H7096	1H7097	1H7098	102487

\*\* For Evenly Distributed Load

# Closed Clipper Units



Closed type shelving units are covered on three sides with steel panels to provide stability, protection and to promote cleanliness of stored items. Optional locking doors may be added for greater security.

The 36 configurations shown below with their respective End Kits employ Heavy Duty Hi-Performance® shelves with box posts at the front and offset angle posts at the rear.

Label holders and closed front bases are not included and must be ordered separately. Refer to page 3 for ordering instructions.

Standard stock color is 028 Gray; refer to the inside back cover for complete color information. Many other configurations can be designed from the component parts and accessories on the following pages.

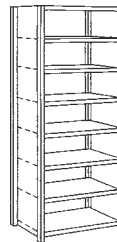

- Basic Unit**
- 1 box post
  - 2 angle posts
  - 1 side panel
  - 1 back panel
  - shelves
  - hardware



- End Kit**
- 1 box post
  - 1 side panel
  - hardware

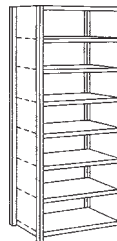
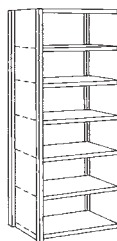
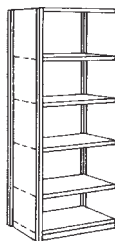
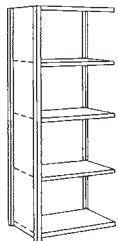

## CLOSED TYPE SHELVING

Box Post at Front  
Offset Angle Posts at Rear

Order Closed Bases Separately

5 Shelf	6 Shelf	7 Shelf	8 Shelf	End Kit	Capacity ** Per Shelf	Dimensions (inches)		
Basic Unit Cat. No.	Basic Unit Cat. No.	Basic Unit Cat. No.	Basic Unit Cat. No.	End Kit Cat. No.	Pounds	W	D	H
1H8015 1H8025 1H8035	1H8016 1H8026 1H8036	1H8017 1H8027 1H8037	1H8018 1H8028 1H8038	1C1287 1C1887 1C2487	800 850 800	36	12 18 24	87 87 87
1H8045 1H8055 1H8065	1H8046 1H8056 1H8066	1H8047 1H8057 1H8067	1H8048 1H8058 1H8068	1C1287 1C1887 1C2487	600 600 600	42	12 18 24	87 87 87
1H8075 1H8085 1H8095	1H8076 1H8086 1H8096	1H8077 1H8087 1H8097	1H8078 1H8088 1H8098	1C1287 1C1887 1C2487	500 500 530	48	12 18 24	87 87 87

\*\* For Evenly Distributed Load







# 36" Wide Clipper Bin Units

Clipper Shelving Bin Units are closed units with Heavy Duty Hi-Performance® shelves, in various quantities, plus dividers and bin fronts as required. Offset angle posts are used at the rear of each unit, and box posts at the front. Order one End Kit to finish a unit or row of units.

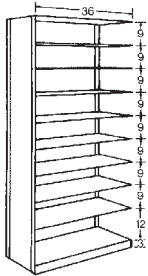
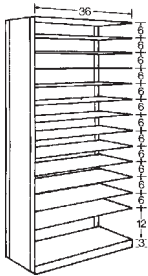
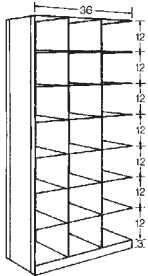
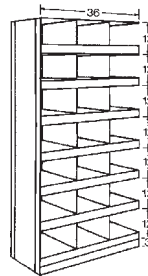
Front bases are included. Label holders must be ordered separately. This and the following page catalog 36" & 48" wide units, but many other configurations are possible by ordering component parts. Most units are available for quick shipment in 028 Gray. See inside back cover for other colors.

Note: Bin widths are nominal. They are measured from the hole centers on the shelves, not the vertical bead of the dividers.

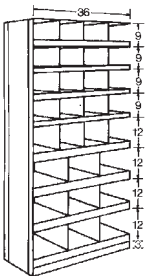
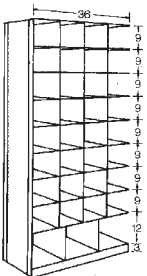
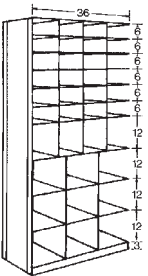
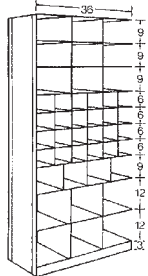
87" High					
	9 OPENINGS 8 36" x 9" 1 36" x 12"	13 OPENINGS 12 36" x 6" 1 36" x 12"	21 OPENINGS 21 12" x 12"	21 OPENINGS 21 12" x 12" 7 3" Bin Fronts	END KIT
Depth	Cat. No.	Cat. No.	Cat. No.	Cat. No.	Cat. No.
12"	1H6109	1H6113	1H6121	1H6621	1C1287
18"	1H6209	1H6213	1H6221	1H6521	1C1887
24"	1H6309	1H6313	1H6321	1H6421	1C2487





87" High					
	29 OPENINGS 16 9" x 9" 4 9" x 12" 9 12" x 12" 8 3" Bin Fronts	35 OPENINGS 32 9" x 9" 3 12" x 12"	37 OPENINGS 24 9" x 6" 4 9" x 12" 9 12" x 12"	43 OPENINGS 24 6" x 6" 9 12" x 9" 4 9" x 9" 6 12" x 12"	END KIT
Depth	Cat. No.	Cat. No.	Cat. No.	Cat. No.	Cat. No.
12"	1H6129	1H6135	1H6137	1H6143	1C1287
18"	1H6229	1H6235	1H6237	1H6243	1C1887
24"	1H6329	1H6335	1H6337	1H6343	1C2487

# 48" Wide Clipper Bin Units

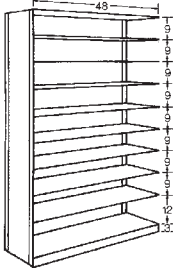
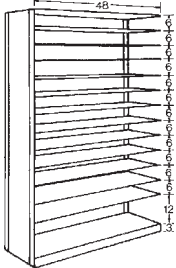
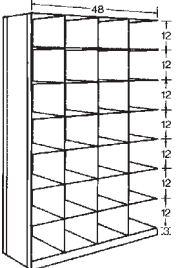
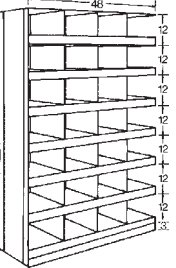

## CLIPPER<sup>®</sup> SHELVING

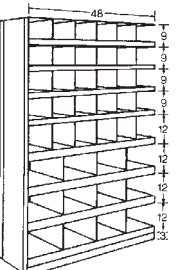
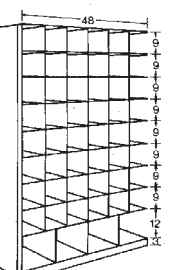
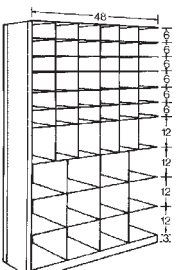
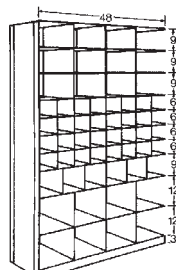
Note: Bin widths are nominal. They are measured from the hole centers on the shelves, not the vertical bead of the dividers.

 <p><b>9 OPENINGS</b></p> <p>8 48" x 9" 1 48" x 12"</p>	 <p><b>13 OPENINGS</b></p> <p>12 48" x 6" 1 48" x 12"</p>	 <p><b>28 OPENINGS</b></p> <p>28 12" x 12"</p>	 <p><b>28 OPENINGS</b></p> <p>28 12" x 12" 7 3" Bin Fronts</p>	 <p><b>END KIT</b></p>	<p><b>87" High</b></p>
<p><b>Cat. No.</b></p> <p>1H6409 1H6509 1H6609</p>	<p><b>Cat. No.</b></p> <p>1H6413 1H6513 1H6613</p>	<p><b>Cat. No.</b></p> <p>1H6428 1H6528 1H6628</p>	<p><b>Cat. No.</b></p> <p>1H6328 1H6228 1H6128</p>	<p><b>Cat. No.</b></p> <p>1C1287 1C1887 1C2487</p>	
 <p><b>42 OPENINGS</b></p> <p>16 7-1/2" x 9" 8 9" x 9" 4 7-1/2" x 12" 2 9" x 12" 12 12" x 12" 8 3" Bin Fronts</p>	 <p><b>52 OPENINGS</b></p> <p>32 7-1/2" x 9" 16 9" x 9" 4 12" x 12"</p>	 <p><b>54 OPENINGS</b></p> <p>24 7-1/2" x 6" 12 9" x 6" 4 7-1/2" x 12" 2 9" x 12" 12 12" x 12"</p>	 <p><b>58 OPENINGS</b></p> <p>32 6" x 6" 12 12" x 9" 4 7-1/2" x 9" 2 9" x 9" 8 12" x 12"</p>	 <p><b>END KIT</b></p>	<p><b>87" High</b></p>
<p><b>Cat. No.</b></p> <p>1H6442 1H6542 1H6642</p>	<p><b>Cat. No.</b></p> <p>1H6452 1H6552 1H6652</p>	<p><b>Cat. No.</b></p> <p>1H6454 1H6554 1H6654</p>	<p><b>Cat. No.</b></p> <p>1H6458 1H6558 1H6658</p>	<p><b>Cat. No.</b></p> <p>1C1287 1C1887 1C2487</p>	



# Ledge & Counter Units

## Ledge Units

Ledge type shelving is recommended where greater depth of the lower compartment is desired, and a convenient working height surface ledge is required. Seven Heavy Duty Hi-Performance® shelves are included plus a heavy gauge ledge top with a reinforcing pan welded to the bottom for extra strength. This provides a total of seven openings.

The units are available in open or closed construction and may be equipped with standard shelving accessories, including locking doors at the top and the bottom. Units are 36" wide, 12" deep at the top, and 24" deep at the bottom. Overall height is 87"; the ledge top is 39" high.

The End Kit includes 2 ledge top finishing strips to provide a finished appearance at the sides of the ledge top. Order one End Kit to finish each single unit, or row of units.



Open Unit with End Kit



Closed Unit with End Kit

### Open Type Ledge Unit

Size W x D x H	Unit Cat. No.	End Kit Cat. No.
36" x 12/24" x 48/39"	1H432L	19433E

### Closed Type Ledge Unit

36" x 12/24" x 48/39"	1H434L	19435E
-----------------------	--------	--------

## Counter Units

Penco steel counters present an extremely clean, classic appearance for over the counter or stockroom use. A smooth, extra heavy gauge reinforced counter top provides an excellent work surface. Three standard Heavy Duty Hi-Performance® Clipper shelves, adjustable on 1" centers, are used below. Units have box posts at all four corners.

The top is designed to butt against adjacent tops when more than one unit is used in a row for a continuous flush surface. One End Kit is required for each single unit, or to end a row of units. Two counter top finishing strips are included with each End Kit, to extend the top beyond the end and provide a finished appearance.



Front and rear views of 2 1H122C Basic Units plus 1 19125E End Kit

Size W x D x H	Unit Cat. No.	End Kit Cat. No.
36" x 24" x 39"	1H122C	19125E
42" x 24" x 39"	1H123C	19125E
48" x 24" x 39"	1H124C	19125E

Counter Tops and Fronts may be purchased as separate components. Note that they may be used only when box posts are used at front and rear of unit.

### Counter Tops Only

Size W x D	Cat. No.
36" x 24"	13670H
42" x 24"	13680H
48" x 24"	13690H

### Counter Fronts Only

Size W x H	Cat. No.
36" x 39"	13870H
42" x 39"	13880H
48" x 39"	13890H



## Artwork Shelving



This efficient unit serves the need for storing, organizing and protecting artwork. It is a basic piece of storage equipment wherever artwork is maintained. The unit has 18 openings, each with a 26-3/4" clear vertical opening. The unit includes closed back, sides and base, four Hi-Performance® shelves and 15 dividers. Dividers adjust easily on 1-1/2" centers. Can be accessorized with lockable doors. Order End Kit to finish each unit or row.

Shown in Light Putty (723) enamel. Available in other standard Clipper Shelving Colors.

## Open Shelf Filing Record Storage



A space-saving efficient unit designed for filing a variety of records in a safe, organized, easily accessible system. Special tabbed dividers insert into the shelf and special back bracket for divider stability. They adjust easily on alternate 1" and 2" centers. The unit features closed sides and base. A special bracket at each shelf level is pierced to accept one tab of the divider. Order End Kit to finish a unit or row.

Shown in Light Putty (723) enamel. Available in other standard Clipper Shelving colors.

NOTE: Utilizes 18 ga. Standard Flange Shelves only.

Basic Unit				End Kit
Size W x D x H	No. of Shelves	No. of Dividers	Catalog Number	Catalog Number
36" 24" 87"	4	15	1H6700	1C2487

Basic Unit				End Kit
Size W x D x H	No. of Shelves	No. of Dividers	Catalog Number	Catalog Number
36" 12" 87"	8	35	176709	1C1287

## X-Ray Shelving



An efficient, practical storage unit with a broad application throughout the healthcare industry for the protective storage of X-rays. The unit features Heavy Duty Hi-Performance shelves, closed back, sides, and base. 25 dividers are furnished in two sizes which adjust easily on 1-1/2" centers. The dividers attach to the shelf with strong plastic buttons. Order End Kit to finish each unit or row.

Shown in Light Putty (723) enamel. Available in other standard Clipper Shelving colors.

Refer to opening sizes in chart below.

Basic Unit				End Kit
Size W x D x H	No. of Shelves	No. of Dividers	Catalog Number	Catalog Number
36" 18" 87"	6	25	1H6705	1C1887
<b>Divider Quantities</b>	15 - 18"D x 16"H - Cat. No. 15860H - Clear Opening 14-13/16" H 10 - 18"D x 18"H - Cat. No. 15870H - Clear Opening 16-13/16" H			

## Plan Shelving



Designed with the engineer, draftsman or architect in mind, this unit allows plans and drawings to be stored either rolled or flat. This unit provides 64 openings 6" x 36" x 6" for rolled storage and 9 openings 48" x 36" x 4" for flat storage. Unit includes Heavy Duty Hi-Performance shelves, closed back, sides and base. Can be accessorized with lockable doors. Order End Kit to finish each row.

Shown in Light Putty (723) enamel. Available in other standard Clipper Shelving colors.

Basic Unit				End Kit
Size W x D x H	No. of Shelves	No. of Dividers	Catalog Number	Catalog Number
48" 36" 87"	18	56	1H6659	1C3687



Box Post

Offset Angle Post

**Box Posts** – A high strength roll formed tubular box section usually used at unit fronts; permits full access to shelf width. Designed to be used in common between units, or at row ends. Permits vertical shelf adjustment on 1" centers using clips or nuts & bolts. Internal flange is punched on 3" centers to accept side sway bracing or closed side panels.

**Offset Angle Posts** – A roll formed high strength post which permits 1" vertical shelf adjustment, using clips or nuts & bolts. Can be used at rear of units, or at front and rear. Offset recess adds rigidity and allows for independent shelf clip adjustment. Ends of flanges are punched on 3" centers to accept sway braces or closed panels.

Height	14 Ga. Cat. No.	16 Ga. Cat. No.
39"	1B4039	-
48"	1B4048	-
75"	1B4075	-
87"	1B4087	1B6087
99"	1B4099	-
123"	1B4123	-
147"	1B4147C	-

Height	14 Ga. Cat. No.	16 Ga. Cat. No.
39"	1A4039	-
48"	1A4048	-
75"	1A4075	-
87"	1A4087	1A6087
99"	1A4099	-
123"	1A4123	-
147"	1A4147C	-

Unbraced Length (Max. Space Between Shelves)	Double Angle (Bolted on 12" Centers)		
	Box Post	Single Angle	
9"	6740	3760	8270
12"	6450	3490	7670
15"	6070	3130	6880
18"	5630	2700	5940
21"	5090	2180	4790
24"	4480	1680	4460



Closed Upright Assembly

### Closed Upright Assemblies

Steel Panels used to close the sides of 87" high shelving units. Panels are securely welded to posts for rigidity, helping to reduce installation time and costs.

Deep	High	Box Post	Offset Angle Post	Box Post Intermediate
12"	87"	1 Box Post 1 Angle Post 1 Side Panel	2 Offset Angles 1 Side Panel	1 Box Post 2 Offset Posts 1 Side Panel
		Cat. No.	Cat. No.	Cat. No.
12"	87"	15412CC	15412AC	15412BC
18"	87"	15418CC	15418AC	15418BC
24"	87"	15424CC	15424AC	15424BC

**A & B. Clipper Clips** – One piece 14 gauge rugged compression clip inserts into either box or offset angle posts to hold shelf securely while allowing easy removal if changes are needed.

A — Cat. No. 10002Z - For Hi-Performance Shelves  
B — Cat. No. 100001Z - For Standard Flange Shelves

**D. Floor Anchor Clip** – Heavy gauge device punched for fastening posts to floor. Includes hardware to fasten to post. Catalog No. 10006Z

**E. Foot Plate** – Used to distribute unit load and protect the floor. For box and angle post. Catalog No. 10007Z

**C. Post Splice** – Used to join Box or Angle posts for high rise or mezzanine applications. One per post. Catalog No. 10030H

**Shim, 11 Gauge** - (not shown) For optional placement beneath Floor Anchor Clip. Catalog No. 10011C

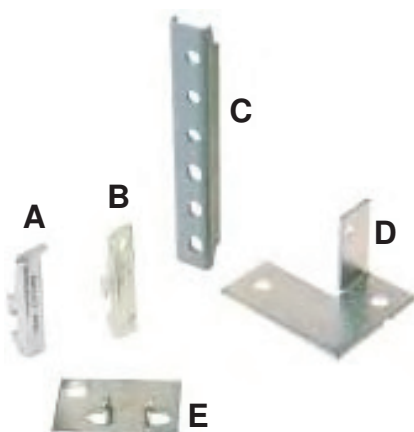

## Open Construction

### Sway Braces

Sway braces provide stability for Open Type shelving. They are furnished in sets of two braces to fasten to one back or side of a unit. Hardware included.

Back sway braces eliminate lateral sway. They fasten to the flanges of offset angle posts used at the rear of units. Braces also bolt to each other at the center hole to ease installation.

Side sway braces eliminate front to back sway. They fasten to the flanges of the front and rear posts.

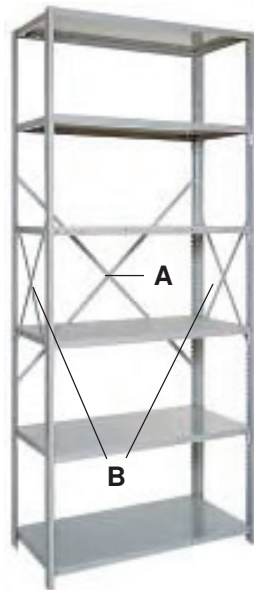

### Back Sway Braces (A)

Unit Width (inches)	Overall Length (inches)	Cat. No.
24	45	12045A
30	50	12050A
36	50-3/4	12036H
42	57-1/8	12042H
48	65-1/2	12048H

### Side Sway Braces (B)

Unit Depth (inches)	Overall Length (inches)	Cat. No.
9	11	12011S
12	15	12015S
15	19	12019S
18	26	12026S
24	34	12034S
30	45	12045S
32	46-1/4	12046S
36	49	12049S

### Corner Angle Braces

For applications requiring clear entry to shelves front and rear, Corner Angle Braces may be used. Contact your Penco representative for pass-thru applications. Not recommended for two level shelving. Hardware included.

E. For box posts used in common with two standard flange shelves. Used at front and rear of unit.

Catalog No. 10044H

F. For angle post only. Use at front and rear of unit.

Catalog No. 10043H

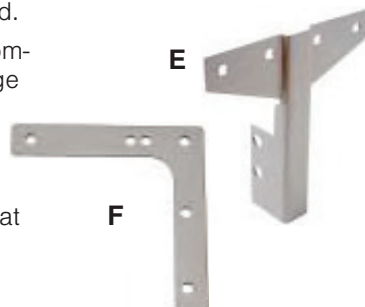

## Closed Construction

### Back and Side Panels

Panels to enclose the backs and sides of Closed Type Shelving provide unit stability while giving greater protection to the shelving contents.

Back panels fasten to the flanges of offset angle posts at the rear of units. The center of the back is held tight against a shelf with a "back panel clip" furnished with each back. Common backs may be used when units are placed back-to-back, provided that units are securely bolted together.

Backs 36" wide are furnished in one piece through 87" high. Over 87" high, they are split horizontally (2 pieces). 42" & 48" wide backs are furnished in one piece through 51" high; above 51" they are split horizontally (2 pieces). Hardware included.

Side panels fasten to the flanges in the front and rear posts. Furnished in one piece through 87" high. As an alternate to side panels, you may order Closed Upright Assemblies (shown on the previous page) which combine posts and side panels in one welded unit.

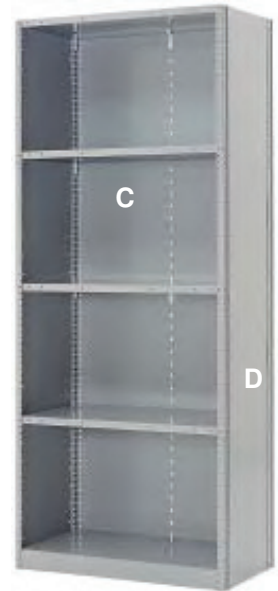

### Back Panels (C)

Height (inches)	Shelf Width (inches)				
	24 Cat. No.	30 Cat. No.	36 Cat. No.	42 Cat. No.	48 Cat. No.
39	-	-	12500H	12600H	12700H
51	-	-	12510H	12610H	12710H
75	-	-	12530H	12630H	12730H
87	12340H	12440H	12540H	12640H	12740H
99	-	-	12550H	12650H	12750H

### Side Panels (D)

Height (inches)	Shelf Depth (inches)						
	9 Cat. No.	12 Cat. No.	15 Cat. No.	18 Cat. No.	24 Cat. No.	30 Cat. No.	36 Cat. No.
39	-	11400H	-	11600H	11700H	11800H	11900H
48	-	11409H	-	11609H	-	-	-
51	-	11410H	-	11610H	11710H	-	-
75	-	11430H	-	11630H	11730H	-	11930H
87	11340H	11440H	11540H	11640H	11740H	11840H	11940H
99	-	11450H	-	11650H	11750H	11850H	11950H



# Hi-Performance® Shelves

Clipper Hi-Performance® Shelves maximize load handling capacity through a design which shapes the front and rear flanges into rigid tubular box beams. The box shape provides two vertical surfaces in each box-flange that inherently give it a high strength-to-weight ratio.

The shelves are efficiently manufactured from high strength cold rolled steel on a modern automated roll forming mill.

For additional strength, flanges of the box beams are welded to the underside of the shelf on 3" centers. Shelf corners are lapped and welded.

Shelves are available in a wide variety of sizes shown below in the capacity chart. All shelves are punched on the face and surface to accept shelving accessories such as dividers, label holders and bin fronts.

## Clipper Hi-Performance Shelf Capacities



Medium Duty Class 0 Medium Duty High Strength Steel			Heavy Duty Class 1 Heavy Duty High Strength Steel		Extra Heavy Duty Class 2 Extra Heavy Duty High Strength Steel		Extra Heavy Duty With Reinforcing - See Note (1)
W x D	Cat. No.	Capacity	Cat. No.	Capacity	Cat. No.	Capacity	Capacity
36" x 12"	1H223612C	500	1H203612C	800	1H183612C	1100	-
36" x 15"	1H223615C	500	1H203615C	800	1H183615C	1100	-
36" x 18"	1H223618C	500	1H203618C	850	1H183618C	1200	2000
36" x 24"	1H223624C	500	1H203624C	800	1H183624C	1250	2000
36" x 30"	-	-	1H203630C	500	1H183630C	900	2000
36" x 36"	-	-	1H203636C	500	1H183636C	900	2000
42" x 12"	-	-	1H204212C	600	1H184212C	1100	-
42" x 15"	-	-	1H204215C	600	1H184215C	1100	-
42" x 18"	-	-	1H204218C	600	1H184218C	1050	1600
42" x 24"	-	-	1H204224C	600	1H184224C	900	1600
42" x 30"	-	-	1H204230C	625	1H184230C	1000	1600
42" x 32"	-	-	1H204232C	525	1H184232C	950	1600
42" x 36"	-	-	1H204236C	475	1H184236C	900	1600
48" x 12"	1H224812C	350	1H204812C	500	1H184812C	750	-
48" x 15"	-	-	1H204815C	500	1H184815C	850	-
48" x 18"	1H224818C	375	1H204818C	500	1H184818C	900	1200
48" x 24"	1H224824C	400	1H204824C	500	1H184824C	900	1200
48" x 30"	-	-	1H204830C	500	1H184830C	750	1200
48" x 36"	-	-	1H204836C	500	1H184836C	750	1200

All shelves are supplied with Clipper Clips.

All shelf load capacities are in pounds for evenly distributed loads, and include a safety factor of 1.65.

Note: (1): Class 3 capacities are based upon the use of Extra Heavy Duty Shelves with (A) Side Shelf Supports and

(B) Center Support for additional capacity. Must use nuts and bolts for shelves, not clips.



Clipper bins at parts distribution center



A. Class 3 Side Shelf Support (pairs): Used to support Center Support in Class 3 applications.

Depth	Cat. No.
18"	1H830H
24"	1H840H
30"	1H850H
36"	1H860H



B. Class 3 Center Support: Runs left to right beneath the mid-point of the shelf for conversion to Class 3. Supported by side shelf supports.

Width	Cat. No.
36"	H13736C
42"	H13742C
48"	H13748C

# Conventional Flange Shelves



Clipper Conventional Flange Shelves are fabricated from 18 gauge cold rolled steel. All sides of the shelf are double flanged for added strength. The corners are lapped and welded for positive reinforcement. Shelves secure to posts with Penco's unique compression Clipper clip, or can be bolted. Shelves are punched laterally for divider placement on alternating 1" and 2" centers.

## Clipper Conventional Flange Shelf Capacities - 18 Gauge



Class 0				Class 1-B	Class 2-B	Class 2-A
For Normal Loads No additional reinforcement.				For Normal Loads Requiring Impact Resistance. A Standard Class 0 Shelf with the addition of a 1" x 1/8" reinforcing bar in the front flange.	For Medium Loads. Same as Class 1-B with the addition of a reinforcing bar in the rear flange.	For Medium to Heavy Loads. A standard Class 0 shelf with the addition of field installed 1" x 1" x 1/8" reinforcing angles in front and rear flanges.
Shelf Size W x D	Class 0 Cat. No.	Deflection At Center Front Edge	Capacity		Capacity	Capacity
24" x 12"	12810C	.200"	990		1270	1580
24" x 18"	12830C	.200"	1110		1430	1430
24" x 24"	12840C	.200"	1140		1090	1090
30" x 12"	12910C	.250"	760		980	1230
30" x 18"	12930C	.250"	820		1060	1320
30" x 24"	12940C	.250"	920		1030	1030
36" x 9"	13000C	.300"	620	Class 1, shelves do not have appreciably more load carrying capabilities over Class 0, but should be used where impact or concentrated loads occur along the front edge.	790	980
36" x 12"	13010C	.300"	620		810	1010
36" x 15"	13020C	.300"	620		820	1020
36" x 18"	13030C	.300"	660		850	1050
36" x 24"	13040C	.300"	700		920	1090
36" x 30"	13050C	.300"	790		860	860
36" x 36"	13060C	.300"	740		740	740
42" x 12"	13110C	.350"	520		690	850
42" x 15"	13120C	.350"	520	690	860	
42" x 18"	13130C	.350"	550	710	880	
42" x 24"	13140C	.350"	580	740	930	
42" x 30"	13150C	.350"	620	800	800	
42" x 36"	13160C	.350"	680	740	740	
48" x 12"	13210C	.400"	450	590	740	
48" x 18"	13230C	.400"	470	600	770	
48" x 24"	13240C	.400"	480	640	790	
48" x 30"	13250C	.400"	510	670	830	
48" x 36"	13260C	.400"	550	720	720	

All shelves are supplied with Clipper Clips. Nuts and bolts may be substituted upon request. All capacities are for safe static loads distributed uniformly over the entire shelf surface as determined by test. Refer all "Pass Thru" or other unusual conditions to Penco Engineering for their evaluation.



**A - Reinforcing Bar:** Rolled steel bars insert in the shelf channel for reinforcement. Hardware is included.

Wide	Deep	High	Cat. No.
30"	1/8"	1-3/32"	16660H
36"	1/8"	1-3/32"	16670H
42"	1/8"	1-3/32"	16680H
48"	1/8"	1-3/32"	16690H

**B - Reinforcing Angle:** 1/8" thick rolled steel angles added to the shelf flanges for developing class 2A shelves. Hardware is included.

Wide	Deep	High	Cat. No.
36"	1"	1"	16520H
42"	1"	1"	16530H
48"	1"	1"	16540H



Clipper shelving used for records storage



**A - Bin Front:** A formed steel panel partially enclosing the front opening of a shelf to keep bulk items within a bin.

Wide	High	Cat. No.
36"	1"	14210H
36"	2"	14220H
36"	3"	14230C
42"	3"	14330C
48"	3"	14430C

1" & 2" Bin Fronts attach to the front of the shelf with bolts & nuts. Hardware included.

3" high Bin Front attaches to posts with metal clips. Hardware included.

**B - Sliding Divider:** Formed to fit around front and rear flanges on the shelf. Position anywhere on surface. No hardware needed.

#### For Hi-Performance Shelves

Deep	High	Cat. No.
12"	4"	1H4124C
12"	6"	1H4126C
18"	4"	1H4184C
18"	6"	1H4186C
24"	4"	1H4244C
24"	6"	1H4246C

**C - Partial Dividers:** Partially subdivides shelf to separate stored items. Hardware included.

Deep	High	Cat. No.
12"	2"	16395H
12"	4"	16410H
18"	2"	16397H
18"	4"	16430H
24"	4"	16440H

**D - Full Height Dividers:** Used to divide a shelf opening into smaller units. Divider has a beaded front edge for strength and safety. Hardware included. *Note: for Class 3 shelving applications, contact your representative regarding special notching of dividers.*

Deep	High	Cat. No.
12"	6"	15600H
12"	9"	15620H
12"	12"	15640H
12"	14"	15650H
12"	18"	15670H
15"	6"	15700H
15"	12"	15740H
18"	6"	15800H
18"	9"	15820H
18"	10"	15830H
18"	12"	15840H
18"	16"	15860H
18"	18"	15870H
18"	24"	15890H
24"	6"	15900H
24"	9"	15920H
24"	12"	15940H
24"	18"	15970H
24"	24"	15990H
36"	18"	16170H

**E - Label Holders:** A formed steel strip that accepts 7/8" labels. Fastens to the shelf with plastic buttons (included).

Width	Cat. No.
24"	13900H
30"	13910H
36"	13920H
42"	13930H
48"	13940H

#### Front Base Strip



Closes the space between the floor and bottom shelf. Hardware included.

Wide	High	Cat. No.
24"	3"	14500H
30"	3"	14510H
36"	3"	14520H
42"	3"	14530H
48"	3"	14540H

#### Swinging Doors



3 Point latching with locking handle and 2 keys.

NOTE: Not for use with Modular Drawers.

Doors are pre-hung at the factory on a welded frame for easy assembly and good fit. Can be used on standard ledge or counter units up to 87" high. Order doors separately from units. Door can be attached to box posts or angle posts. Base strips should be ordered to close the opening between the door frame and the floor.

Width	Door Frame Height	Unit Height	Pair Cat. No.
(For Below Ledge or Counter Height)			
36"	36"	39"	19600H
(For Above Ledge Unit)			
36"	48"	48"	19610H
(For Standard Shelving Units)			
36"	73"	75"	19630H
36"	85"	87"	19640H
48"	36"	39"	19646H
48"	85"	87"	19650H

#### Sliding Doors



Flanged on all 4 sides and reinforced. Doors slide on quiet, smooth-running nylon rollers and guides. Designed for use with two 36" wide units side by side. Complete with grooved key cylinder lock and 2 keys. Hardware included. Not for use with Modular Drawers.

Width	Door Frame Height	Unit Height	Pair Cat. No.
72"	36"	39"	1H907236
72"	84"	87"	1H907284

## Finished End Panel

Formed sheet steel panels used to finish the end of a shelving row. Panels attach to posts to cover holes and hardware. Presents an attractive and finished appearance.



Deep	High	Cat. No.
12"	87"	18241H
18"	87"	18440H
24"	87"	18540H

Must be used with Box Post at front, Angle Posts at rear.

## Shelf Boxes



This strong compact open topped box measures 4-5/8" high and is ideal for storing small parts where shelves are spaced on 6" centers. It features a full width drawer pull, built-in drawer stop and recessed label holder. Box guides are provided for each row of boxes. Finished in 028 Gray only. Order 2 Shelf Box Guides for each shelf of boxes. Cat. No. 10038H.



## Multi-Level Support Brackets

For attachment of cross aisle decking supports. Bolts to shelving posts.

A – For Box Post  
Cat. No. 10063H

A

B – For Offset  
Angle Post  
Cat. No. 10062H



B

Box Size	Boxes Per	
w x d	Cat. No.	36" Shelf
5-5/8" x 11"	38030	6
8-7/16" x 11"	38035	4
11-1/4" x 11"	38040	3
5-5/8" x 17"	38180	6
8-7/16" x 17"	38185	4
11-1/4" x 17"	38190	3
5-5/8" x 23"	38255	6
8-7/16" x 23"	38260	4
11-1/4" x 23"	38265	3



## Coat Rod Bracket

A metal channel "V" grooved to accept a 1-1/16" O. D. pipe for hanging clothes or other material. Attaches to front and rear posts. Two required per coat rod.

Wide	High	Cat. No.
18"	1-3/4"	14705H
24"	1-3/4"	14706H

Coat Rod – 3/4" Galv. Pipe 1-1/16" O. D.  
36" 9405C  
48" 9406C



## Shelf Box Dividers

Dividers have built-in label holders and drop into slots in the box sides. Adjustment on 1" centers allow you to compartmentalize each box. Galvanized finish.

Size	Cat. No.
w x h	
5-5/8" x 4-1/2"	38306
8-7/8" x 4-1/2"	38307
11-1/4" x 4-1/2"	38308



Closed Clipper Shelving with sliding dividers used for storage of medical records.

Automotive parts warehouse with two level shelving and full height dividers



# Clipper® Specifications

**GENERAL:** All shelving shall comply with SMA and ANSI MH 28.1-1982 and in addition shall have the following characteristics:

**POSTS:** All posts shall be punched for clip or nut and bolt construction. Shelves and accessories are to be vertically adjustable on 1" centers. Side sway braces or side panels to be attached to the side flange of the post. Bolts, nuts, and sway braces or panels shall not obstruct the full adjustability of the shelves.

**BOX POST:** Box post to be roll formed and have overall dimensions of 3/4" wide x 2-7/16" deep. Box post to be flush within 1/4" of the face of the shelves when assembled.

**OFFSET ANGLE:** Offset angle post shall be roll formed and have overall dimensions of 1-1/8" wide x 2-1/2" deep. The rear flange shall be punched to accept sway braces or backs, the side flange shall be punched to accept side sway braces or side panels.

**SIDE PANELS:** Shall be 24 gauge steel. Each side shall be punched with holes for bolting to posts.

**BACKS:** Shall be 24 gauge steel with holes on each side for bolting to angle posts and in the middle for using a back panel clip.

**SWAY BRACES:** To be 12 gauge x 3/4" steel punched at each end for bolting to posts and at the center for strength and ease of assembly

**CLIPPER SHELF CLIP:** One piece 14 gauge rugged compression type to insert into either box or offset angle posts to form a positive four point connection. Clips shall have two claw-like hooks to seat firmly into post slots and two tabs at bottom to seat into post holes for a tight friction connection. All clips for all posts and shelves to be the same. Design shall offer a pre-clipping feature to simplify erection. Finish: zinc plated. All shelves are to have four independently adjustable clips.

**SHELVES: CONVENTIONAL FLANGE, CLASS "O":** Shall be 18 gauge steel with a 1-3/16" vertical face on all four sides, front and rear faces to have 17/32" return flange 90° with the edges coined upward to prevent snagging. Sides to have a 5/8" return flange 90°. All four shelf corners shall be closed by lapping and spot welding together to provide a firm, rigid shelf. Shelf shall be universally punched for use with all available accessories and for clip or bolted assembly. Shelves are available in 24", 30", 36", 42" and 48" widths and 9", 12", 15", 18", 24", 30" and 36" depths. Shelves can be reinforced by adding 1-3/32" x 11 ga. bars or 1" x 1" x 1/8" angles to front and back flanges.

**SHELVES: CLIPPER HI-PERFORMANCE® BOX FORMED:** Medium Duty, Heavy Duty and Extra Heavy Duty are manufactured from cold rolled steel in three material thicknesses that provide up to three different shelf capacities per size. Shelves have 1-1/4" face on all four sides. Front and rear faces have four 90° bends providing a 3/4" x 1-1/4" high tubular shape with an 11/16" wide flange seated against the underside of the shelf. The flange is spot welded to the underside of the shelf on 3" centers. Sides have a 5/8" return flange 90°. All four corners are closed by lapping and spot welding together. Medium Duty and Heavy Duty shelf tabs for lapping and welding have formed ribs to maintain the same snug fit in the shelf clip as the extra heavy duty shelf. Overall, the shelf depth and width is 1/4" less than nominal. The shelf is punched for divider adjustment on 1-1/2" centers and for attachment of label holders, bin fronts and base fronts. Hi-Performance shelves are available in 36", 42", & 48" widths and 12", 15", 18", 24", 30" & 36" depths.

Extra Heavy Duty Reinforced (Class 3) Hi-Performance Shelves provide maximum capacity using Extra Heavy Duty shelves that are reinforced using 13 gauge side shelf supports bolted to the Clipper posts and 14 gauge 1-5/32" high hat shaped center supports held in place by a notch and flange in the side shelf support.

**LEDGE TOPS:** To be 14 gauge steel. Face of ledge to be 1-1/8" and have a center reinforcing pan. Ledge top to project 1-1/8" beyond the face of the post and to have two 14 gauge angles welded to underside for strength and bolting to post. Must be used with box posts below ledge.

**LEDGE ENDS:** To be manufactured from 14 gauge steel and furnished to give ledge top a finished appearance.

**COUNTER TOPS:** To be 14 gauge steel. Face of counter top to be 1-1/8" and project 1-1/8" beyond face of post with a welded center reinforcing pan. Units to be furnished with box post front and rear for finished appearance. 14 gauge counter top ends can be furnished at the ends of all rows for a finished appearance.

**COUNTER FRONT:** To be 18 gauge steel attached with no exposed fasteners.

**BASE STRIP:** Shall be 18 gauge steel attached to face of shelf with bolts and nuts to close space between the bottom of the shelf and the floor.

**LABEL HOLDER:** Shall be 24 gauge steel with necessary holes for attaching to shelves with plastic push-in fasteners.

**SHELF DIVIDERS:** 6" high through 20" high shall be 24 gauge, 24" high and over shall be 20 gauge. All divider front flanges shall have a 5/16" diameter bead. Top, bottom and rear flanges are 7/8". Dividers less than 24" high shall be attached with plastic push-in fasteners, 24" and higher are bolted.

**PARTIAL DIVIDERS:** Shall be 18 gauge steel with a 7/8" flange at the bottom. Attached with push-in Plastic Button fasteners.

**SLIDING DIVIDER:** To be 20 gauge steel manufactured to give infinite lateral adjustability. Divider portion shall be sloped 45° at front, 1/2" radius at front corner.

**BIN FRONTS:** To be 18 gauge steel. One and two inch high bin fronts shall be bolted to the face of the shelf. Three inch high bin fronts to be attached to the post by use of 16 gauge zinc plated channel clips.

**SHELF BOXES:** To be 20 gauge steel with a rigid curled handle at the front of the box, punched with an integral card holder on front and rear. Box shall be 4-5/8" high to fit between shelves on 6" centers and shall be slotted to accept dividers on 1" centers.

**SHELF BOX DIVIDERS:** To be 20 gauge steel. Punched with an integral card holder.

**SWINGING DOORS:** Consist of a 16 gauge steel frame and 20 gauge doors, reinforced to prevent warping. Doors are riveted to three 5-knuckle hinges and have a three-point latching device with chrome plated key lock handle. Doors to be preassembled in the frame at factory.

**SLIDING DOORS:** Set of doors is 72" wide and cover two 36" wide units. Each door shall be 22 gauge with two or more 18 gauge reinforcing pans, recessed handle and nylon glides and rollers. Each set has 16 gauge channels welded at the top and bottom, and 20 gauge channels on the ends. Doors shall be contained in top, bottom and vertical channels. Right hand door has a provision for a cylinder lock.

**FOOT PLATES:** Shall be 13 gauge zinc plated steel and be used to protect floors.

**FINISH:** All painted parts shall be selected from a minimum of five standard colors. Materials shall be cleaned and phosphatized in a multi-stage process, dried in a 400° oven and electrostatically spray painted with a high grade enamel and baked on at 360°.

Clipper® and Hi-Performance® are registered trademarks of Penco Products, Inc.

PENCO RESERVES THE RIGHT TO VARY SPECIFICATIONS CONSISTENT WITH OUR POLICY OF CONTINUOUS PRODUCT IMPROVEMENT.



# Heavy Duty Modular Drawers



- For 36" Wide Clipper Shelving Units

- Available for 18" & 24" depths



## The Cubic Advantage

- 400 lb. capacity per drawer
- Improve inventory control
- Increased versatility
- Reduce stockroom labor
- Reduce inventory damage
- Improved security
- Economy through accessibility
- Efficient space utilization

With Clipper® Heavy Duty Modular Drawers in shelving you can effectively utilize your storage space above as well as below your drawers. By consolidating your bulk storage needs in the same floor space taken up by a conventional drawer cabinet unit, you can increase your storage capabilities up to 40% or more! Penco Modular Drawers can be installed at any level, and can be moved if your needs change. If you need drawers, your present Clipper shelving installation can be retrofitted right now without the capital expense of new shelving or cabinets.

Best of all, Penco Modular Drawers are truly modular. All heights and adjustments are on 1" centers, drawers can be interchanged and switched (2-3" drawers replace a 6" drawer etc.). The wide variety of sizes and drawer subdivision possibilities make this system versatile enough to fill practically any need.

Can be used in units with either Hi-Performance or Standard Flange Shelves.

### Heavy Duty Modular Drawers

Provide secure high density storage of small parts. Heavy duty 100% full suspension allows full view of contents. Available in a variety of sizes with a wide range of accessories. Can be added to existing shelving installations.

### How To Order Modular Drawers For Shelving

- The easiest way to order Clipper Heavy Duty Modular Drawers is by selecting the Drawer Kit that matches your needs, and then add the appropriate Drawer Interior Subdivision.
- If you need to order from parts and accessories:
  - Select the size of mounting brackets.
  - Order drawer front sizes that add up to the bracket size.
  - Order one shelf closure strip per mounting bracket kit.
  - Order partitions & dividers, plus any accessories sized to fit your application.
- Color: Drawers, brackets and carriage are finished in Putty 3. Partitions are Gray.

NOTE: We strongly recommend that shelving be floor anchored, wall anchored, or cross aisle top tied. For Floor Anchoring Clip order Catalog Number 10006Z.

NOT FOR USE WITH SHELVING DOORS.

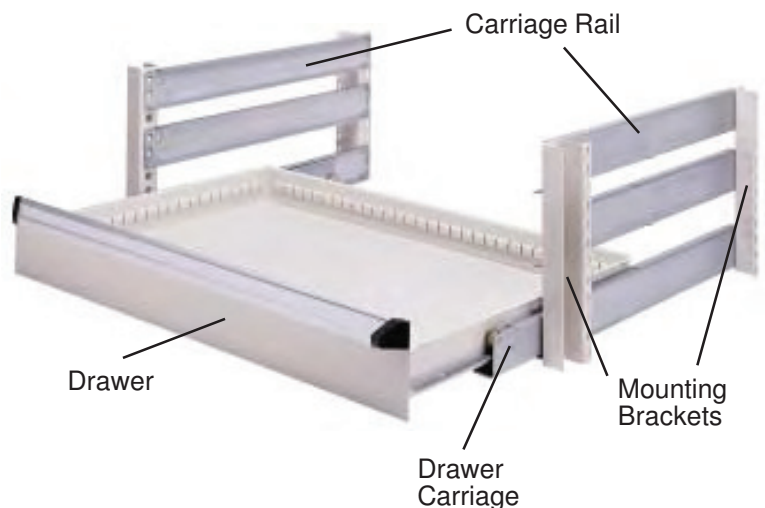



## Modular Drawer Kits

All Clipper Modular Drawer Kits come complete with mounting brackets, drawer, carriage, rails, hardware and shelf closure strips necessary to install easily into new or existing Clipper shelving. All are available for 18" and 24" deep shelving. Drawer combinations shown are representative of the most popular configurations. See the Components page to design drawer combinations not shown.



### Three Drawer Kit

Overall Height – 12"  
 18" Deep 24" Deep  
 Cat. No. Cat. No.  
 1MK601P 1MK602P



### Four Drawer Kit

Overall Height – 12"  
 18" Deep 24" Deep  
 Cat. No. Cat. No.  
 1MK603P 1MK604P

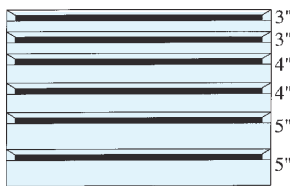

### Six Drawer Kit

Overall Height – 24"  
 18" Deep 24" Deep  
 Cat. No. Cat. No.  
 1MK605P 1MK606P

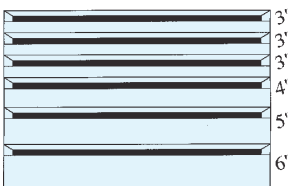

### Six Drawer Kit

Overall Height – 24"  
 18" Deep 24" Deep  
 Cat. No. Cat. No.  
 1MK607P 1MK608P

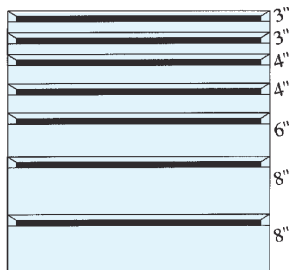

### Seven Drawer Kit

Overall Height – 36"  
 18" Deep 24" Deep  
 Cat. No. Cat. No.  
 1MK609P 1MK610P



### Seven Drawer Kit

Overall Height – 56"  
 18" Deep 24" Deep  
 Cat. No. Cat. No.  
 1MK611P 1MK612P

**NOTE:** All overall height dimensions do not include the shelves placed at the top and bottom of the drawers.

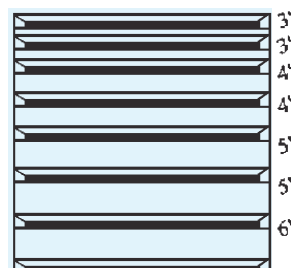

### Eight Drawer Kit

Overall Height – 36"  
 18" Deep 24" Deep  
 Cat. No. Cat. No.  
 1MK613P 1MK614P

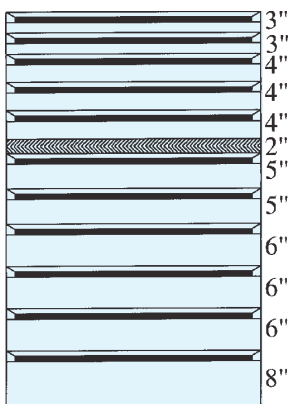

### Eleven Drawer Kit

Overall Height – 56"  
 18" Deep 24" Deep  
 Cat. No. Cat. No.  
 1MK615P 1MK616P

## Interior Subdivisions

### Calculating Compartment Dimensions

The slots in all sides of each drawer are on nominal 1" centers (.97"). Partitions, which are inserted from front to rear, have the same slot pattern as the sides. The diagram below enables you to figure the exact compartment sizes of interior subdivisions.

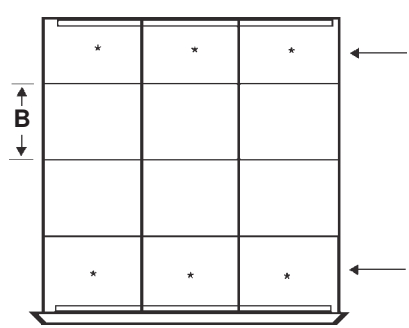
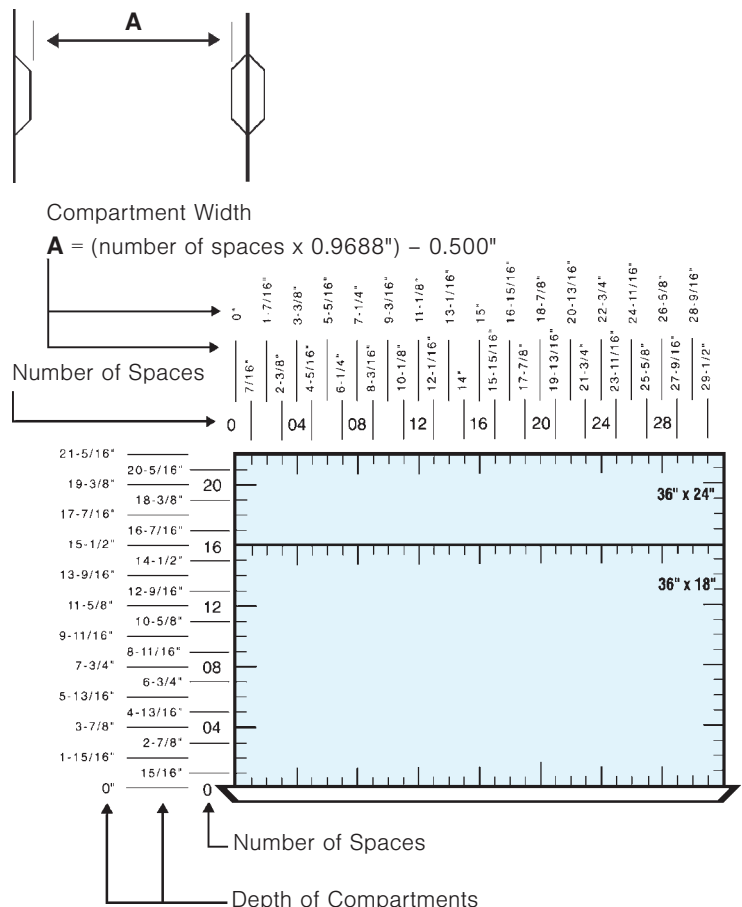

# Heavy Duty Modular Drawers



Organized storage of small parts is achieved by dividing the drawer body into smaller compartments. Illustrated are the most common configurations. To customize your own drawer compartments, order partitions and dividers

separately. Compartment dimensions are clear opening sizes. Catalog numbers are provided for convenient ordering of partitions and dividers only. Order drawers separately. Partitions and dividers are not factory installed.

## Interior Subdivisions For 24" Deep Shelving

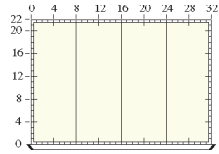

**4 Compartments  
Drawer Front**

Height	Cat. No.
3"	1MD069
4"	1MD071
5"	1MD070
6"	1MD072
8"	1MD073

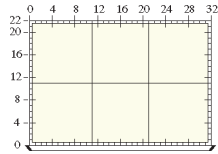

**6 Compartments  
Drawer Front**

Height	Cat. No.
3"	1MD103
4"	1MD105
5"	1MD104
6"	1MD106
8"	1MD107

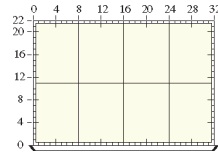

**8 Compartments  
Drawer Front**

Height	Cat. No.
3"	1MD075
4"	1MD077
5"	1MD076
6"	1MD078
8"	1MD079

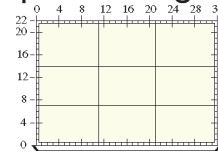

**9 Compartments  
Drawer Front**

Height	Cat. No.
3"	1MD111
4"	1MD108
5"	1MD127
6"	1MD109
8"	1MD110

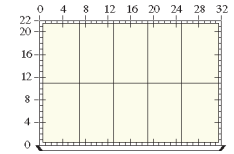

**10 Compartments  
Drawer Front**

Height	Cat. No.
3"	1MD043
4"	1MD045
5"	1MD044
6"	1MD046
8"	1MD047

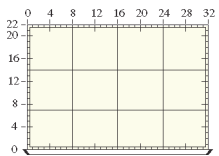

**12 Compartments  
Drawer Front**

Height	Cat. No.
3"	1MD081
4"	1MD083
5"	1MD082
6"	1MD084
8"	1MD085

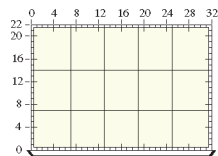

**15 Compartments  
Drawer Front**

Height	Cat. No.
3"	1MD049
4"	1MD051
5"	1MD050
6"	1MD052
8"	1MD053

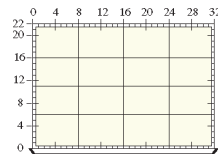

**16 Compartments  
Drawer Front**

Height	Cat. No.
3"	1MD087
4"	1MD089
5"	1MD088
6"	1MD090
8"	1MD091

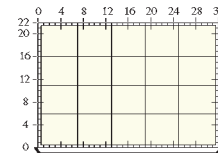

**20 Compartments  
Drawer Front**

Height	Cat. No.
3"	1MD055
4"	1MD057
5"	1MD056
6"	1MD058
8"	1MD059

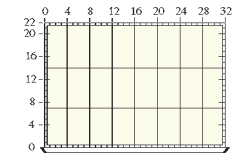

**24 Compartments  
Drawer Front**

Height	Cat. No.
3"	1MD092
4"	1MD094
5"	1MD128
6"	1MD095

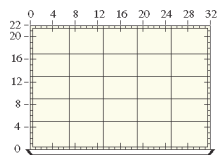

**25 Compartments  
Drawer Front**

Height	Cat. No.
3"	1MD061
4"	1MD063
5"	1MD062
6"	1MD064
8"	1MD065

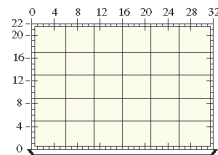

**30 Compartments  
Drawer Front**

Height	Cat. No.
3"	1MD066
4"	1MD067
5"	1MD129
6"	1MD068

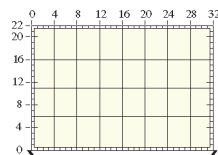

**32 Compartments  
Drawer Front**

Height	Cat. No.
3"	1MD096
4"	1MD097
5"	1MD130
6"	1MD098

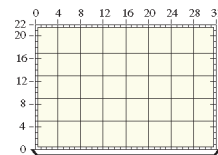

**40 Compartments  
Drawer Front**

Height	Cat. No.
3"	1MD099
4"	1MD101
5"	1MD131
6"	1MD102

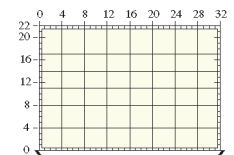

**48 Compartments  
Drawer Front**

Height	Cat. No.
3"	1MD093

## Interior Subdivisions For 18" Deep

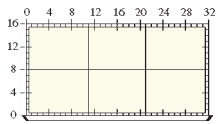

**6 Compartments  
Drawer Front**

Height	Cat. No.
3"	1MD013
4"	1MD015
5"	1MD014
6"	1MD016
8"	1MD017

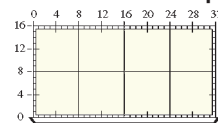

**8 Compartments  
Drawer Front**

Height	Cat. No.
3"	1MD019
4"	1MD021
5"	1MD018
6"	1MD022
8"	1MD023

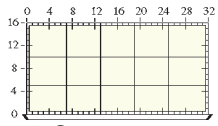

**15 Compartments  
Drawer Front**

Height	Cat. No.
3"	1MD025
4"	1MD027
5"	1MD026
6"	1MD028
8"	1MD029

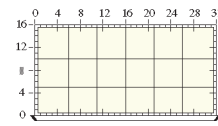

**18 Compartments  
Drawer Front**

Height	Cat. No.
3"	1MD031
4"	1MD033
5"	1MD032
6"	1MD034
8"	1MD035

## Drawer Interior with Plastic Bins

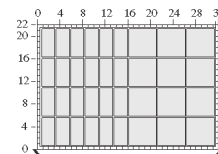

**36 Plastic Bins  
Drawer Front**

Height	Cat. No.
3"	1MD124
4"	1MD126

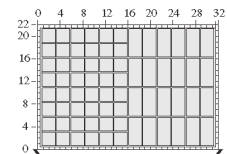

**72 Plastic Bins  
Drawer Front**

Height	Cat. No.
3"	1MD120
4"	1MD122

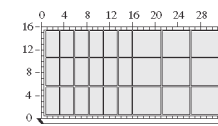

**27 Plastic Bins  
Drawer Front**

Height	Cat. No.
3"	1MD116
4"	1MD118

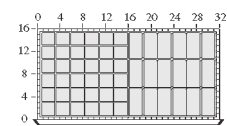

**54 Plastic Bins  
Drawer Front**

Height	Cat. No.
3"	1MD112
4"	1MD114

## Modular Drawers



All drawers are furnished complete with a heavy duty roller bearing carriage, carriage rails, extruded aluminum pull with built-in label holder, label, clear acetate label cover and hardware. Capacity is 400 pounds, evenly distributed.

### 18" Deep Shelving

Interior Dimensions: 30" w. x 15" d.

### 24" Deep Shelving

Interior Dimensions: 30" w. x 21" d.

Drawer Front Height*	Drawer Body Height	Usable Drawer Height	18" Deep Cat. No.	24" Deep Cat. No.
3"	1-1/2"	2"	1MD301P	1MD307P
4"	2-1/2"	3"	1MD302P	1MD308P
5"	3-1/2"	4"	1MD303P	1MD309P
6"	4-1/2"	5"	1MD304P	1MD310P
8"	6-1/2"	7"	1MD305P	1MD311P

\* Actual height 1/16" less.

## Mounting Bracket Kit



Includes four brackets and hardware for fastening to shelving posts.

Height	Cat. No.
12"	1MK112P
18"	1MK118P
24"	1MK124P
36"	1MK136P

## Shelf Closure Strip



A finish trim strip which fastens to the shelf and closes the gap above the top drawer.

Size	Cat. No.
2"	1M137H

## Partitions



Runs from front to rear to separate drawer left to right. Accepts dividers in pre-punched slots.

Shelving Depth	Drawer Front Height	Cat. No.
18"	3"	1M336H
18"	4"	1M339H
18"	5"	1M338H
18"	6"	1M342H
18"	8"	1M345H
24"	3"	1M337H
24"	4"	1M340H
24"	5"	1M341H
24"	6"	1M343H
24"	8"	1M347H

## Dividers

Zinc plated dividers insert into slots for easy adjustment.



Drawer Front Height	No. of Slots Wide	Cat. No.
3"	4	1M0331
3"	5	1M0332
3"	6	1M0333
3"	7	1M0334
3"	8	1M0335
3"	10	1M0337
3"	11	1M0338
4"	4	1M0347
4"	5	1M0348
4"	6	1M0349
4"	7	1M0350
4"	8	1M0351
4"	10	1M0353
4"	11	1M0354
5"	4	1M0339
5"	5	1M0340
5"	6	1M0341
5"	7	1M0342
5"	8	1M0343
5"	10	1M0344
5"	11	1M0345
6"	4	1M0356
6"	5	1M0357
6"	6	1M0358
6"	7	1M0359
6"	8	1M0376
6"	10	1M0378
6"	11	1M0379
8"	4	1M0381
8"	5	1M0382
8"	6	1M0383
8"	7	1M0384
8"	8	1M0385
8"	10	1M0386
8"	11	1M0388

## Plastic Bins



Sturdy gray molded plastic bin for small parts has built-in label holder.

Drawer Front Height	Nominal Dimension w x d x h			Cat. No.
3"	2-1/2"	2-1/2"	1-1/2"	1M0001
3"	2-1/2"	5"	1-1/2"	1M0002
3"	5"	5"	1-1/2"	1M0003
4"	2-1/2"	2-1/2"	2-1/2"	1M0004
4"	2-1/2"	5"	2-1/2"	1M0005
4"	5"	5"	2-1/2"	1M0006

## Label Holder

Attaches to divider. Accepts 2-1/4" wide x 3/4" label.



Cat. No. 1M0009

## Drawer Locking Mechanism

Contains two keyed alike built-in cylinder locks and prevents drawers from being opened. Supplied with two keys.\*

Mounting Bracket Height	Cat. No.
12"	1MK412
18"	1MK418
24"	1MK424
36"	1MK436



\*NOTE: If more than one set of brackets is used in a single shelving unit, contact your Penco representative for applicable locking mechanism.

# Clipper Applications



*Archives records storage.*



*Multi-level shelving with open deck above second level.*



*Automobile parts distribution center.*



*Upper level of retail mail order central warehouse.*



*Industrial parts warehouse makes good use of shelving with bins.*



*High density record storage.*



*Two level automotive parts storage.*

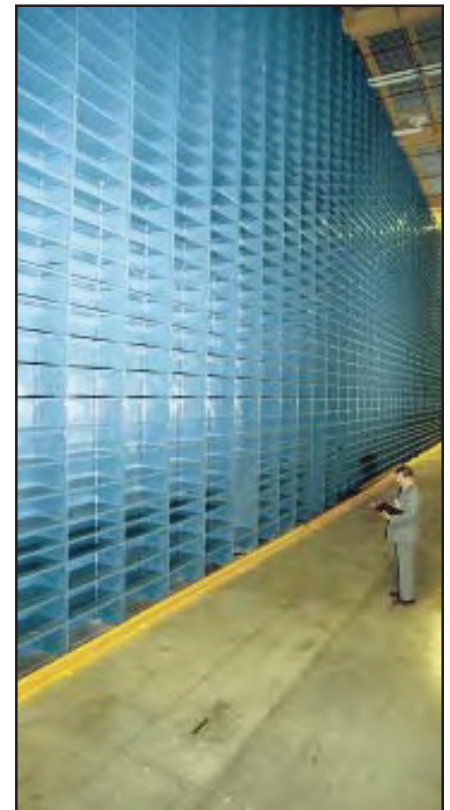

*40' high shelving ready for loading.*